

DU-3000-50-1

MERT

A	B	C	D
90	50	100	65

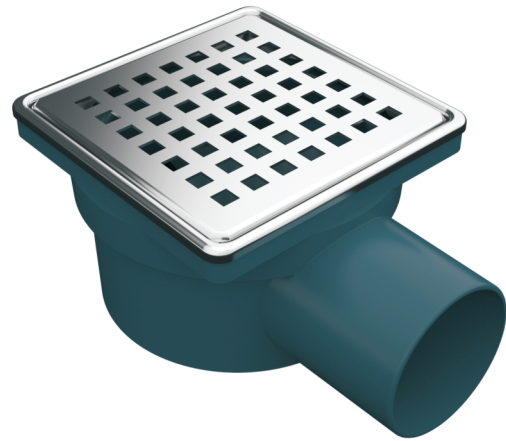

Ausgang Edelstahlrost Ablaufleistung
Ø 50 100*100 0,8l/s

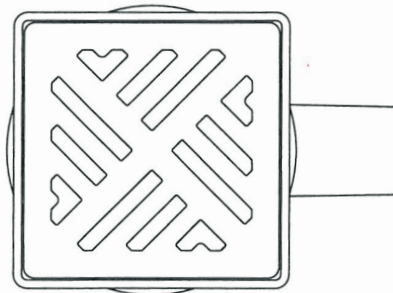
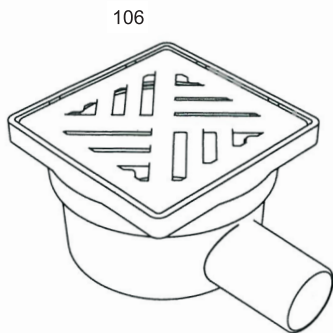
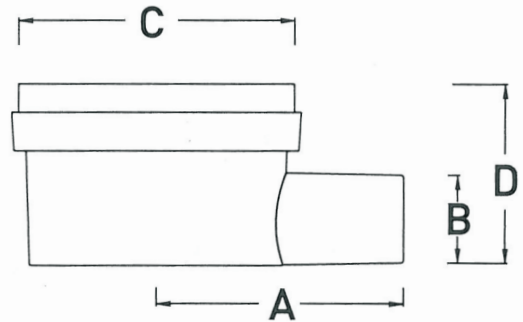
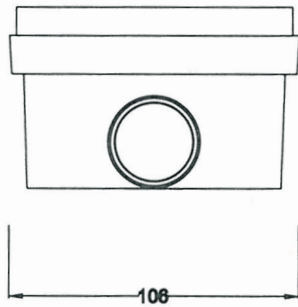

DU-3000-50-A

MERT

A 50 **B** 88 **C** 100 **D** 47



Ausgang Edelstahlrost Ablaufleistung
Ø 50 100*100 0,8l/s

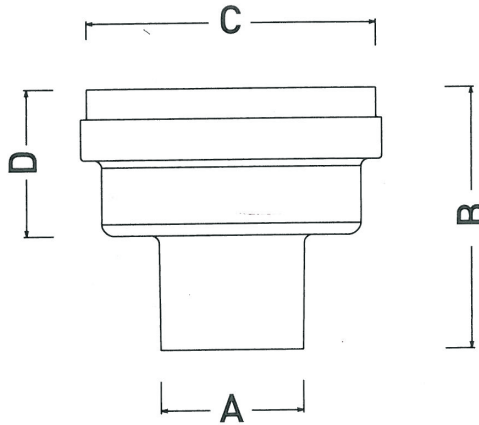
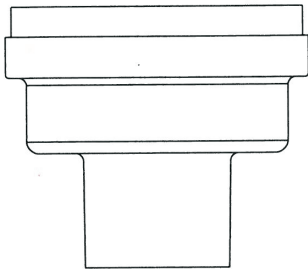

100*100 mm Edelstahlrost

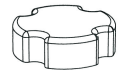

Geruchsverschluss

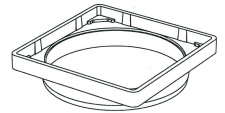

drehbarer Kunststoffrahmen

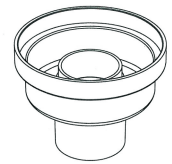
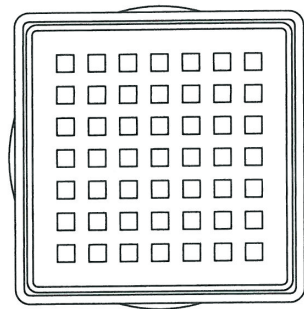
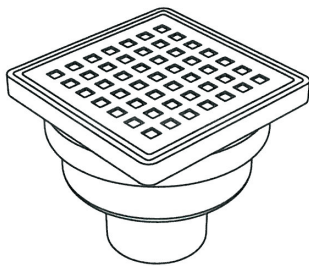

Ø 50 mm Ausgang, klassischer Ablauf

DU-3003-50-A

MERT

A 50 **B** 88 **C** 150 **D** 47

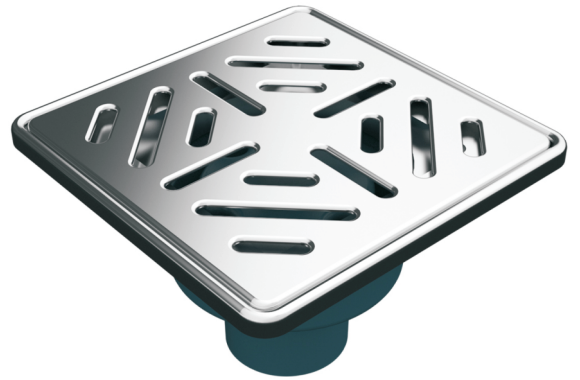

Ausgang Edelstahlrost Ablaufleistung
Ø 50 150*150 0,8l/s

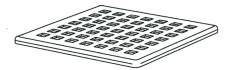
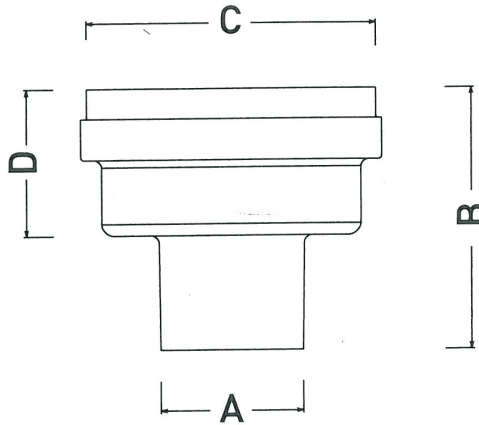
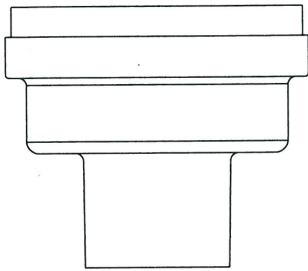

150*150 mm Edelstahlrost

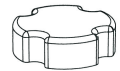

Geruchsverschluss

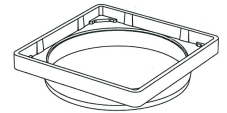

drehbarer Kunststoffrahmen

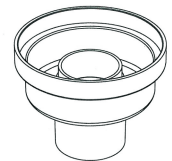
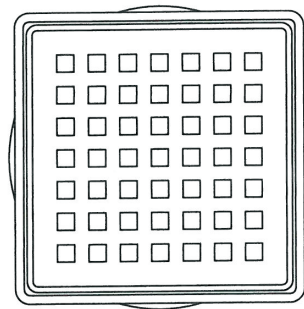
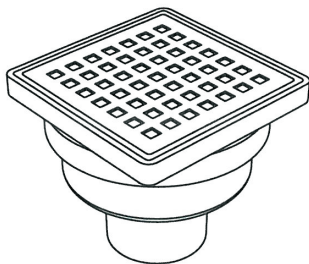

Ø 50 mm Ausgang, klassischer Ablauf

DU-3003-50

MERT

A 90 **B** 50 **C** 150 **D** 65



Ausgang Edelstahlrost Ablaufleistung
Ø 50 150*150 0,8l/s

